

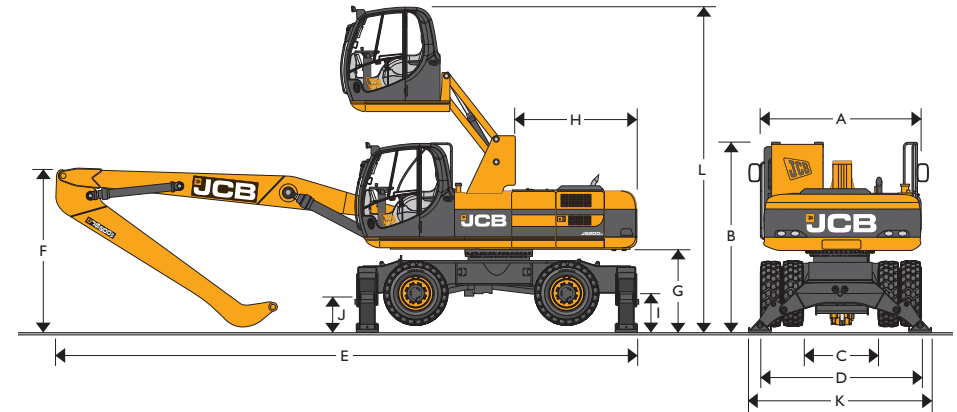

MAX. OPERATING WEIGHT: MATERIALS HANDLER – 25825kg (56934lb) SCRAP HANDLER – 25712kg (56685lb) ENGINE POWER: 128kW (172hp)

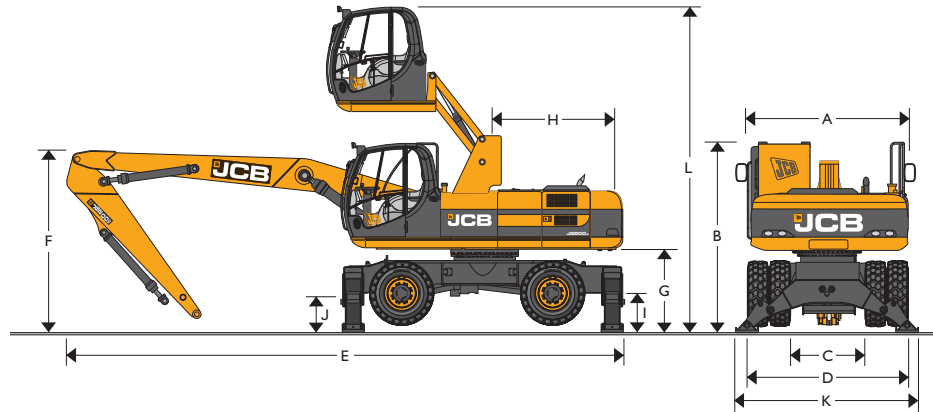

STATIC DIMENSIONS – MATERIALS HANDLER

Dimensions in millimetres (ft-in)	
A Overall width (handrail removed)	2500 (8-2)
B Height over cab	3250 (10-8)
C Internal width between dual wheels	1240 (4-1)
D External width over dual wheels	2530 (8-4)
E Transport length	9500 (31-2)
F Transport height	3150 (10-4)
G Clearance under counterweight	1310 (4-4)
H Tail length	2530 (8-3)
I Height to axle centre line dual wheels	511 (1-7)
J Ground clearance	350 (1-1)
K Full width across stabilisers (down)	3938 (12-11)
Boom length	6800 (22-4)
Dipper length	4000 (13-1)
L Height over cab (raised)	5750 (18-10)

STATIC DIMENSIONS – SCRAP HANDLER

Dimensions in millimetres (ft-in)	
A Overall width (handrail removed)	2500 (8-2)
B Height over cab	3250 (10.8)
C Internal width between dual wheels	1240 (4-1)
D External width over dual wheels	2530 (8-4)
E Transport length	9110 (29-11)
F Transport height	4200 (13-9)
G Clearance under counterweight	1310 (4-4)
H Tail length	2530 (8-3)
I Height to axle centre line dual wheels	511 (1-7)
J Ground clearance	350 (1-1)
K Full width across stabilisers (down)	3938 (12-11)
Boom length	6800 (22-4)
Dipper length	5000 (16-5)
L Height over cab (raised)	5750 (18-10)



ENGINE

Type	Isuzu 4HK1X water-cooled, 4 stroke, 4 cylinder in line common rail direct injection, turbo charged intercooled diesel Stage 3A/Tier 3 compliant.
Rated power (ISO14899, SAE J1995)	128kW (172hp) @ 2000rpm.
Piston displacement	5.193 litres
Starting system	24 volt.
Batteries	2 x 12 volt Heavy Duty.

SWING SYSTEM

Drive train	Axial piston motor and planetary reduction final drive.
Swing brake	Hydraulic braking plus automatic spring applied disc type parking brake.
Swing speed	6rpm
Swing gear	Large diameter, internally toothed fully sealed grease bath lubricated.
Swing lock	Multi position switchable brake and mechanical lock.

CHASSIS

Structure	High strength section.
Chassis	Front and rear stabilisers.
Stabilisers	Front and rear pin mount, independently operable – plus combinations.
Transmission	Hydrostatic drive via piston motor and powershift transmission.
Travel speed	Low ratio 8kph (5mph) Creep speed 3kph (2mph)
Axles	Four wheel drive. Front steering oscillating axle.
Axle load capacity	42 tonnes
Axle oscillation	+/- 8.5 degrees
Ground clearance	350mm (1ft 1in)
Steering	Fully hydraulic system.
Turning radius	6.61m (21ft 8in)
To outside of tyres	
Brakes	All hydraulic, dual circuit brake system.
Parking Brake	Built into the transmission.

EXCAVATOR END

Boom	6.8m (22ft 4in) straight boom.
Dippers	4.0m (13ft 1in) straight materials handling dipper with tipping link. 5.0m (16ft 5in) gooseneck dipper.

MAIN HYDRAULIC SYSTEM

System	Load-sensed hydraulic system with variable flow piston pump providing flow-on-demand for maximum efficiency.
Main pump	Variable displacement axial piston type
Maximum flow	2 x 214 l/min (93 UK gpm)
Main circuit pressure	343 bar (4879 lb/in ²)
With power boost	372 bar (5395 lb/in ²)
Servo pump	Gear type
Maximum flow	31 l/min (7 UK gpm)
Servo pressure	40 bar (580 lb/in ²)
Optional Circuits:	
Hammer	Includes automatic engine speed setting and return filter.
Maximum flow	200 l/min (44 UK gpm)
Maximum pressure	314 (343) bar (4554/4975 lb/in ²)
Hammer/auxiliary combined	(pre-set to 180 bar) (2610 lb/in ²)
Bucket to grab operation	
Maximum flow	138 l/min (30 UK gpm)
Maximum pressure for grab ram operation	330 (343) bar (4785/4975 lb/in ²)
Low Flow Pipework	Two options available, one with 20L/min (4 UK gpm) flow and a second with an adjustable flow of 27-45L/min (6-10 UK gpm).
Hydraulic Cylinders	With hardened, chromed piston rods and end cushioning on boom, dipper and bucket crowd cylinder.
Filtration	
In tank	150 micron, suction strainer.
Main return line	10 micron, fibreform element.
Pilot line	10 micron, paper element.
Plexus by pass line	1.5 micron paper element.
Hydraulic hammer return	10 micron, reinforced microform element.

TYRES

Twins	11.00 x 20 solid tyres with spacer ring.
-------	--

CAB

Excellent digging, loading and positioning visibility results from the careful design of front, side and roof lights. All screens are tinted to improve in cab conditions.

Fully opening front screen is very smooth to operate and as the lower screen is stored within the top screen frame it makes complete front screen opening easy, fast and convenient.

Fresh air ventilation available from opening door window, opening slot in front screen and fully opening front screen.

Parallelogram wash wiper for upper screen ensuring good wiped area for maximum visibility. Wiper motor is fitted in the left hand side of the roof screen so as not to affect bucket visibility when loading. Optional lower screen wiper available.

Fresh air ventilation and heater with windscreen demister. Infinitely variable blower speed, temperature and recirculation control.

Climate control. Fully adjustable deluxe suspension seat with arm rest adjustment and backrest recline. Radio with digital tuner fitted into the roof lining for maximum protection. Conveniently placed radio mute button incorporated into lower console. 12v power point and mobile phone holder built into the right hand console. Courtesy light can be operated from ground level and is illuminated for five minutes or until switched off improving operator access at night. Cab mounted roller blind protects operator from suns' glare through front or top screens.



AMS – ADVANCED MANAGEMENT SYSTEM

Four selectable working modes link the operators control movements with the engine and hydraulic systems to maximise productivity and efficiency.

- A (Auto)** Up to 100% engine power and 100% flow. Gives variable power and speed depending on the operator's input, matching the demand for output and efficiency to the job. Power boost is automatically activated in this mode should hard conditions be encountered. Auto idle cuts in after a period of inactivity (between 5 and 30 seconds as set by the operator)
- E (Economy)** 80% engine power: 95% of hydraulic flow maximises economy while maintaining excellent output.
- P (Precision)** 55% engine power: 90% of hydraulic flow for fine control of grading operations.
- L (Lifting)** 55% engine power: 63% of hydraulic flow with permanent power boost for maximum lifting power and control.

The Auto mode allows the AMS processor to select the optimum operational performance to match the demands of the job while the three alternative modes give precise matching of application when specific tasks are undertaken.

The adjustable position monitor mounted on the front right hand pillar of the cab gives the operator a constant read out of mode, tracking range, operating temperature and a host of other information, while retaining excellent visibility of the monitor and the job being carried out.

The required flow for hammer applications can be set and stored in the AMS memory and is automatically activated whenever the hammer pedal is depressed.

A maintenance indicator warns of imminent service needs, and all servicing and basic checks can be carried out using only the in cab display.

SERVICE CAPACITIES

	litres	UK gal
Fuel tank	330	73
Engine coolant	25.5	5.61
Engine oil	21.5	4.7
Swing reduction gear	5.0	1
Hydraulic system	200	44
Hydraulic tank	120	26
Transmission	3.0	0.70
Axle hubs (each)	2.5	0.55

STANDARD EQUIPMENT

Engine fan guard; Cold start pre-heat; Auto engine warm up; Double element air cleaner; Heavy-duty alternator; Electrics isolator; Heavy-duty batteries; Cab & engine soundproofing; Cab heater & screen demister; Tinted glass; Interior light; Coat hook; Cigarette lighter; Ashtray; Operator's storage shelf; Removable floormat; Windscreen wash/wipe; Plug-in power socket; Automatic power boost; Auto-idle; One-touch engine speed control; Hydraulic cushion control; Plexus hydraulic oil filtration; HSP pressure test points; Auxiliary pipework mounting brackets; Work lights – boom & mainframe mounted; Upper structure under covers; Swing system cover; External mirrors; Handrail & non slip walk ways; Quick connect engine oil drain pipe; Front screen blind; Quick connect fuel tank drain pipe; Hinged engine under cover.

OPTIONAL EQUIPMENT

Hose burst check valves & overload warning system; Tipping link mounted lift points; Climate control; Cab mounted & rear work lights; Rotating beacon; Rain guard; Biodegradable oil; Air suspension seat with heated pad and lumbar support adjustment; Electric refuelling pump; Lower screen wiper; Radio; Cruise control; Grab stowage bar; FOPS (Level 2) operator protection; Biodegradable oil; High and low temperature oils; P3 or carbon filter; Mesh screen guard; Turbo II precleaner; Widecore radiator; Travel alarm.

OPERATING WEIGHTS

	Standard cab kg (lb)	Hydraulic raised cab kg (lb)
Materials handler	23288 (51341)	25825 (56934)
Scrap handler	23175 (51092)	25712 (56685)

Machine equipped with 6.8m (22ft 4in) boom and 4.0m (13ft 1in) straight or 5.0m (16ft 5in) gooseneck dipper, no attachment. Operator and full fuel tank, and solid tyres.

STABILISERS

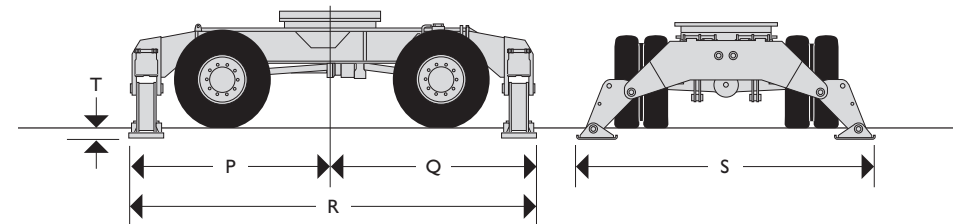

Dimensions in millimetres (ft-in)	
P	Centre of slew ring to front stabilizers 2602 (8-6)
Q	Centre of slew ring to rear stabilizers 2272 (7-5)
R	Length including front and rear stabilizers 4874 (16-0)
S	Width over stabilizers (lowered) 3938 (12-11)
T	Stabilizer lift height 75 (0-3)



WORKING RANGE

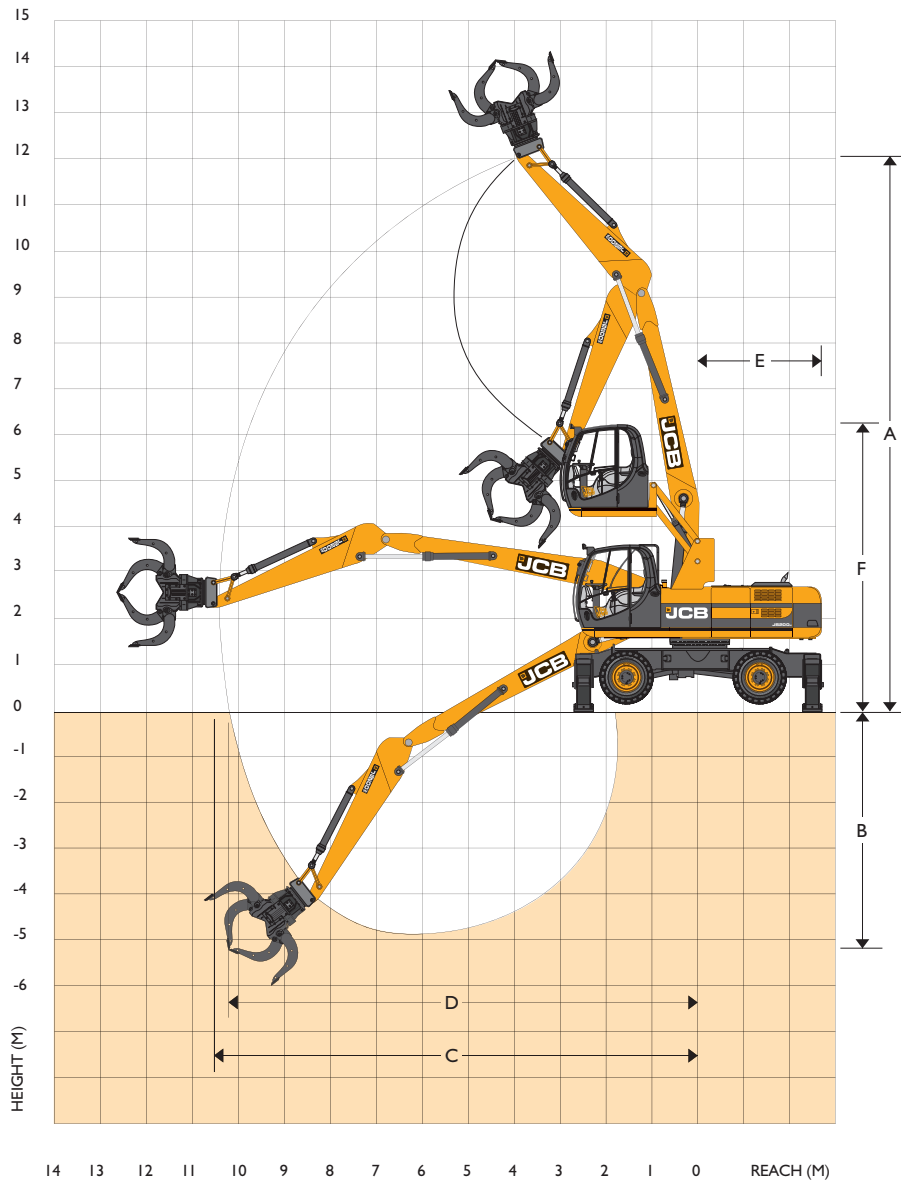

MATERIAL HANDLING

6.8m (22ft 4in) Boom, 4.0m (13ft 1in) Dipper		mm (ft-in)
A	Maximum pin height	12000 (39-4)
B	Maximum pin depth	5250 (17-3)
C	Maximum pin reach	10500 (34-5)
D	Maximum pin reach at ground level	10250 (33-7)
E	Tail swing radius	2530 (8-4)
F	Height over cab (raised)	5750 (18-10)



WORKING RANGE

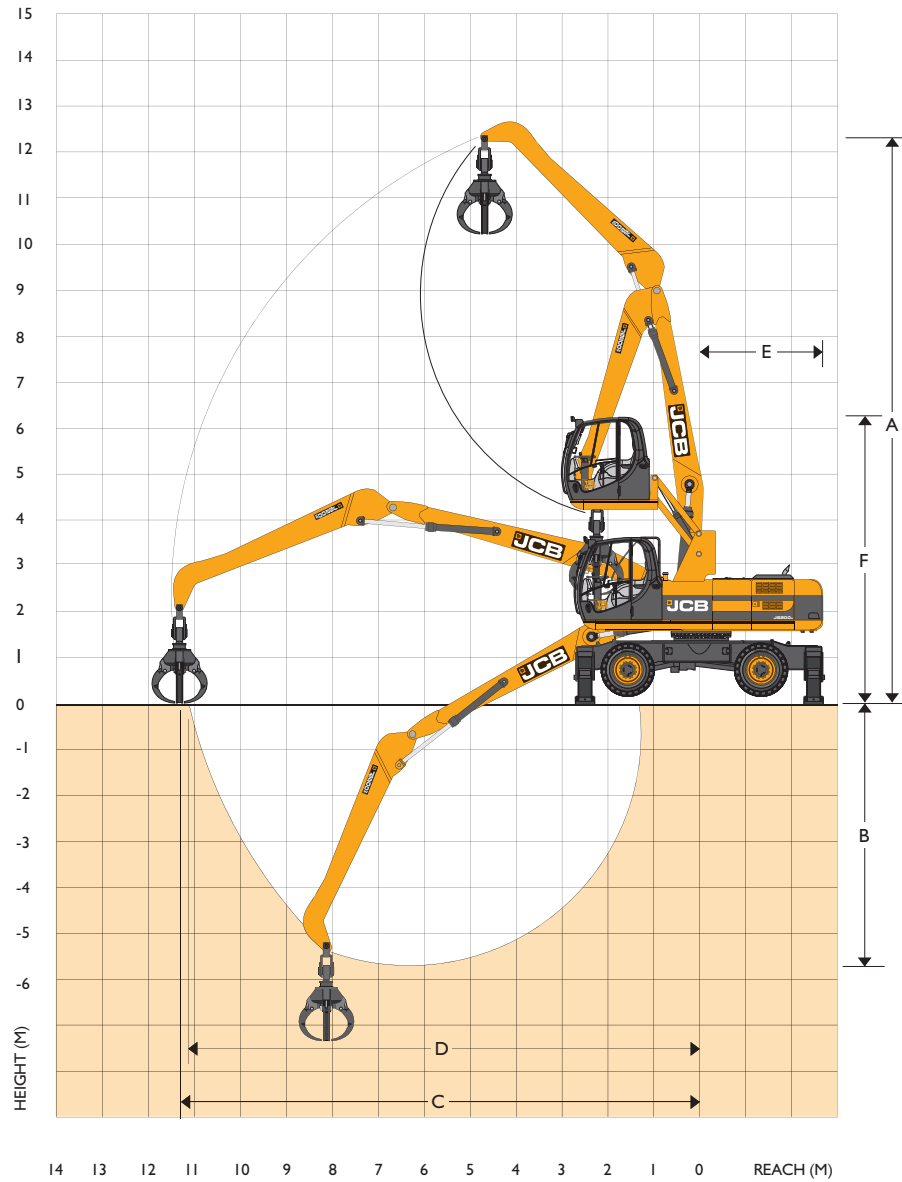

















SCRAP HANDLING

6.8m (22ft 4in) Boom, 5.0m (16ft 5in) Dipper		mm (ft-in)
A	Maximum pin height	12250 (40-2)
B	Maximum pin depth	5750 (18-10)
C	Maximum pin reach	11300 (37-1)
D	Maximum pin reach at ground level	11000 (36-1)
E	Tail swing radius	2530 (8-4)
F	Height over cab (raised)	5750 (18-10)

















LIFT CAPACITIES – 6.8m (22ft 4in) Boom, 4.0m (13ft 1in) Material Handling Dipper, Standard Cab, 4 Stabilisers

JS200W Materials Handler

Reach	1.5m (4ft 11in)		3.0m (9ft 10in)		4.5m (14ft 9in)		6.0m (19ft 8in)		7.5m (24ft 7in)		9.0m (29ft 6in)		10.5m (34ft 5in)		Maximum Reach				
																	kg	kg	mm
Load Point Ht.	kg	kg	kg	kg	kg	kg	kg	kg	kg	kg	kg	kg	kg	kg	kg	kg	kg	kg	mm
9.0m (29.6ft)																	3610*	3610*	7320
7.5m (24.7ft)									3530*	3530*							3250*	3250*	8528
6.0m (19.8ft)							4320*	4320*	3630*	3630*	3150*	3150*					3060*	3060*	9337
4.5m (14.9ft)					6200*	6200*	4690*	4690*	3810*	3810*	3220*	3220*					2950*	2950*	9848
3.0m (9.10ft)					7020*	7020*	5070*	5070*	3990*	3990*	3280*	3280*					2870*	2870*	10107
1.5m (4.11ft)					7410*	7410*	5300*	5300*	4100*	4100*	3300*	330*					2810*	2810*	10134
0m					7140*	7140*	5260*	5260*	4060*	4060*	3210*	3210*					2750*	2750*	9932
- 1.5m (- 4.11ft)			7830*	7830*	6380*	6380*	4890*	4890*	3790*	3790*	2920*	2920*					2650*	2650*	9485
- 3.0m (- 9.10ft)					5200*	5200*	4150*	4150*	3210*	3210*							2450*	2450*	8755
- 4.5m (- 14.9ft)							2930*	2930*	2120*	2120*							2020*	2020*	7658

LIFT CAPACITIES – 6.8m (22ft 4in) Boom, 4.0m (13ft 1in) Material Handling Dipper, Hydraulic Raised Cab, 4 Stabilisers

JS200W Materials Handler

Reach	1.5m (4ft 11in)		3.0m (9ft 10in)		4.5m (14ft 9in)		6.0m (19ft 8in)		7.5m (24ft 7in)		9.0m (29ft 6in)		10.5m (34ft 5in)		Maximum Reach				
																	kg	kg	mm
Load Point Ht.	kg	kg	kg	kg	kg	kg	kg	kg	kg	kg	kg	kg	kg	kg	kg	kg	kg	kg	mm
9.0m (29.6ft)																	3910*	3910*	7320
7.5m (24.7ft)									3830*	3830*							3600*	3600*	8528
6.0m (19.8ft)							4610*	4610*	3970*	3970*	3520*	3520*					3440*	3440*	9337
4.5m (14.9ft)					6620*	6620*	5090*	5090*	4210*	4210*	3620*	3620*					3360*	3360*	9848
3.0m (9.10ft)					7750*	7750*	5620*	5620*	4470*	4470*	3730*	3730*					3310*	3310*	10107
1.5m (4.11ft)					8360*	8360*	5980*	5980*	4650*	4650*	3790*	3790*					3270*	3270*	10134
0m					8190*	8190*	6020*	6020*	4660*	4660*	3730*	3730*					3230*	3230*	9932
- 1.5m (- 4.11ft)			8150*	8150*	745*	7450*	5690*	5690*	4430*	4430*	3460*	3460*					3150*	3150*	9485
- 3.0m (- 9.10ft)					6240*	6240*	4940*	4940*	38440*	3840*							2990*	2990*	8755
- 4.5m (- 14.9ft)							3670*	3670*	2720*	2720*							2600*	2600*	7658



Lift capacity front and rear.



Lift capacity full circle.

Notes:

1. For lifting capacity including bucket, subtract total weight of bucket or bucket and quickhitch from above values.
2. Lifting capacities are based on ISO 10567, that is: 75% of minimum tipping load or 87% of hydraulic lift capacity, whichever is the less. Lifting capacities marked* are based on hydraulic capacity.
3. Lift capacities assume that the machine is on firm, level ground.
4. Lift capacities may be limited by local regulations. Please refer to your dealer.

LIFT CAPACITIES – 6.8m (22ft 4in) Boom, 5.0m (16ft 5in) Scrap Handling Dipper, Standard Cab, 4 Stabilisers

JS200W Scrap Handler

Reach	1.5m (4ft 11in)		3.0m (9ft 10in)		4.5m (14ft 9in)		6.0m (19ft 8in)		7.5m (24ft 7in)		9.0m (29ft 6in)		10.5m (34ft 5in)		Maximum Reach				
																	kg	kg	mm
Load Point Ht.	kg	kg	kg	kg	kg	kg	kg	kg	kg	kg	kg	kg	kg	kg	kg	kg	kg	kg	mm
9.0m (29.6ft)									3640*	36440*						3520*	3520*	8314	
7.5m (24.7ft)									3650*	3650*	3390*	3390*				3330*	3330*	9391	
6.0m (19.8ft)									3810*	3810*	34550*	3450*				3230*	3230*	10130	
4.5m (14.9ft)							4780*	4780*	4070*	4070*	3580*	3580*	3210*	3210*	3190*	3190*	3190*	10602	
3.0m (9.10ft)					7100*	7100*	5360*	5360*	4380*	4380*	3740*	3740*	3260*	3260*	3170*	3170*	3170*	10842	
1.5m (4.11ft)					8060*	8060*	5850*	5850*	4640*	4640*	3860*	3860*	3290*	3290*	3160*	3160*	3160*	10868	
0m					8380*	8380*	6100*	6100*	4770*	4770*	3900*	3900*	3240*	3240*	3160*	3160*	3160*	10680	
- 1.5m (- 4.11ft)	5860*	5860*	8400*	8400*	8070*	8070*	6010*	6010*	4700*	4700*	3790*	3790*			3150*	3150*	3150*	10267	
- 3.0m (- 9.10ft)			9790*	9790*	7240*	7240*	5550*	5550*	4360*	4360*	3440*	3440*			3100*	3100*	3100*	9598	
- 4.5m (- 14.9ft)			7440*	7440*	5880*	5880*	4650*	4650*	3640*	3640*					2940*	2940*	2940*	8612	

LIFT CAPACITIES – 6.8m (22ft 4in) Boom, 5.0m (16ft 5in) Scrap Handling Dipper, Hydraulic Raised Cab, 4 Stabilisers

JS200W Scrap Handler

Reach	1.5m (4ft 11in)		3.0m (9ft 10in)		4.5m (14ft 9in)		6.0m (19ft 8in)		7.5m (24ft 7in)		9.0m (29ft 6in)		10.5m (34ft 5in)		Maximum Reach				
																	kg	kg	mm
Load Point Ht.	kg	kg	kg	kg	kg	kg	kg	kg	kg	kg	kg	kg	kg	kg	kg	kg	kg	kg	mm
9.0m (29.6ft)									3640*	3640*						3520*	3520*	8314	
7.5m (24.7ft)									3650*	3650*	3390*	3390*				3330*	3330*	9391	
6.0m (19.8ft)									3810*	3810*	3450*	3450*				3230*	3230*	10130	
4.5m (14.9ft)							4780*	4780*	4070*	4070*	3580*	3580*	3210*	3210*	3190*	3190*	3190*	10602	
3.0m (9.10ft)					7100*	7100*	5360*	5360*	4380*	4380*	3740*	3740*	3260*	3260*	3170*	3170*	3170*	10842	
1.5m (4.11ft)					8060*	8060*	5850*	5850*	4640*	4640*	3860*	3860*	3290*	3290*	3160*	3160*	3160*	10868	
0m					8380*	8380*	6100*	6100*	4770*	4770*	3900*	3900*	3240*	3240*	3160*	3160*	3160*	10680	
- 1.5m (- 4.11ft)	5860*	5860*	8400*	8400*	8070*	8070*	6010*	6010*	4700*	4700*	3790*	3790*			3150*	3150*	3150*	10267	
- 3.0m (- 9.10ft)			9790*	9790*	7240*	7240*	5550*	5550*	4360*	4360*	3440*	3440*			3100*	3100*	3100*	9598	
- 4.5m (- 14.9ft)			7440*	7440*	5880*	5880*	4650*	4650*	3640*	3640*					2940*	2940*	2940*	8612	

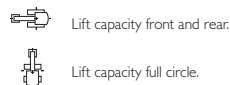

Notes:

1. For lifting capacity including bucket, subtract total weight of bucket or bucket and quickhitch from above values.
2. Lifting capacities are based on ISO 10567, that is: 75% of minimum tipping load or 87% of hydraulic lift capacity, whichever is the less. Lifting capacities marked* are based on hydraulic capacity.
3. Lift capacities assume that the machine is on firm, level ground.
4. Lift capacities may be limited by local regulations. Please refer to your dealer.



A GLOBAL COMMITMENT TO QUALITY

JCB's total commitment to its products and customers has helped it grow from a one-man business into Britain's largest privately owned manufacturer of backhoe loaders, crawler excavators, wheeled excavators, telescopic handlers, wheeled loaders, dump trucks, rough terrain fork lifts, industrial fork lifts, mini/midi excavators, skid steer loaders, tractors and compaction equipment.

By making constant and massive investments in the latest production technology, the JCB factories have become some of the most advanced in the world.

By leading the field in innovative research and design, extensive testing and stringent quality control, JCB machines have become renowned all over the world for performance, value and reliability.

And with a global sales and service network of more than 650 dealers and agents, we aim to deliver the best customer support in the industry.

Through setting the standards by which others are judged, JCB has become one of the world's most impressive success stories.

